

Signage Package Specification

P/N	INF-ITR9606F
Customer P/N	
Version	A1

Revision	Date	Note
1	2022.04.21	New Edition

INF		
DGND.	CHKD.	APPD.

Customer		
DGND.	CHKD.	APPD.

特性 Features

1、高灵敏度、截止可见波长

High sensitivity Cut-Off visible wavelength

2、完全符合RoHs環保標準

The product itself will remain within RoHS compliant version

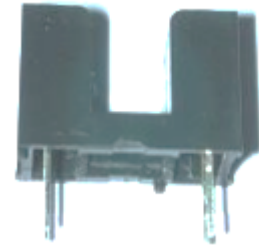

應用範圍 Applications

- ◆ Printer
打印机
- ◆ Switch Scanner
扫描仪开关
- ◆ Non-contact Switching
非接触式开关



Device Selection Guide

Devrce No.	Chip Material	Lens Color
IR	GaAs	Water Clean
PT	Silicon	Water Clean

封裝尺寸 Package Dimensions

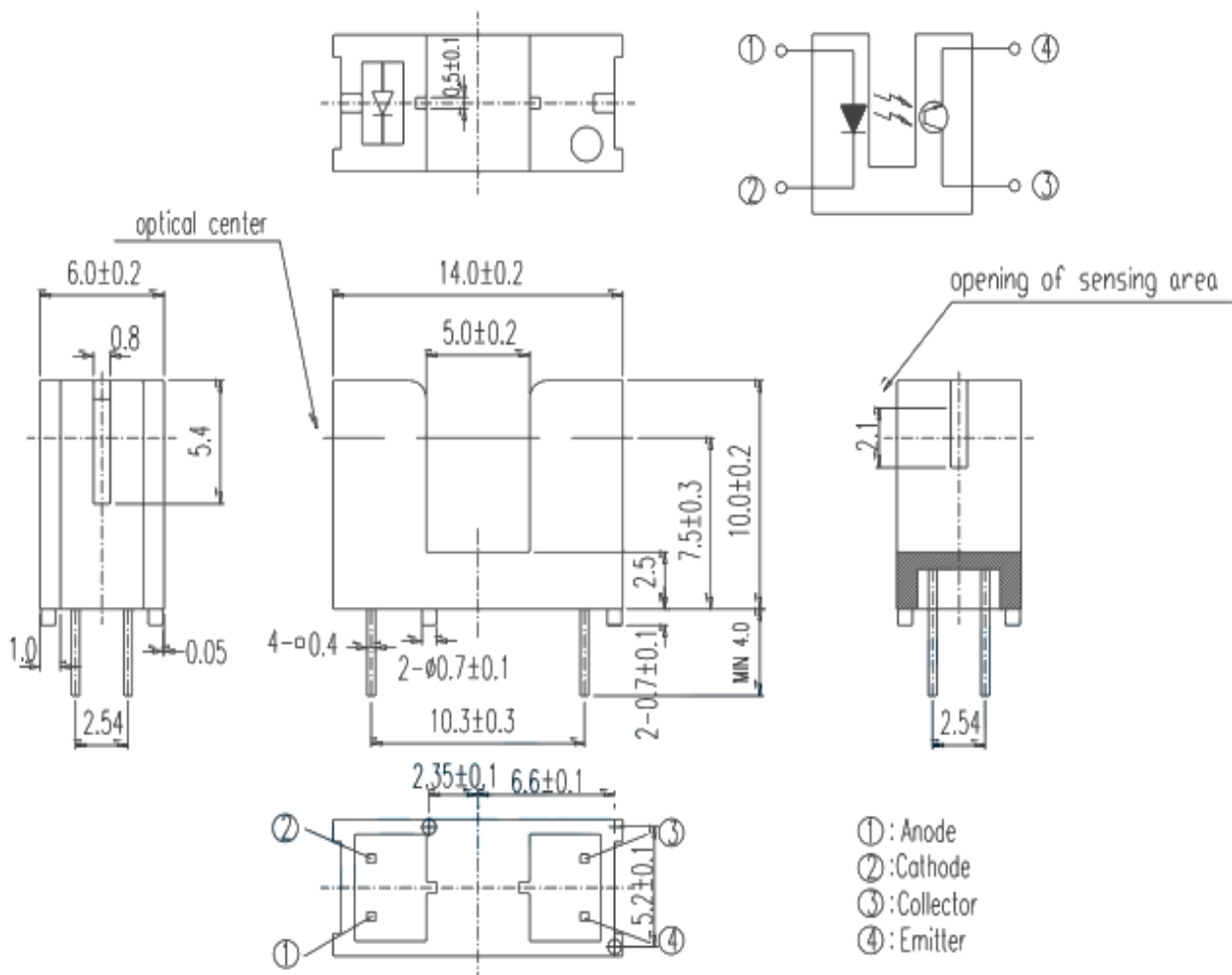

提示 Notes:

1、所有尺寸單位為：mm · 公差為±0.25mm；指定除外。

All dimensions are in millimeters, tolerance is 0.25mm except being specified

◆ 極限參數(Ta=25°C)

Absolute Maximum Rating (Ta=25°C)

	參數名稱 Parameter	符號 Symbol	最大極限數值 Absolute Maximum	單位 Unit
Input 輸入	正向電流 Forward Current	I _F	50	mA
	反向電壓 Reverse Voltage	VR	5	V
	功耗 Power Dissipation at(or below) 25°C Free Air Temperature	P _d	75	mW
Output 輸出	集电极功耗 Collector Power Dissipation	P _c	75	mW
	集电极电流 Collector Current	I _c	20	mA
	发射极电压 Collector-Emitter Voltage	B V _{CEO}	30	V
	集电极电压 Emitter-Collector Voltage	B V _{ECO}	5	V
	工作溫度 Operating Temperature	T _{opr}	-25 ~ +85	°C
	儲存溫度 Storage Temperature	T _{stg}	-40 ~ +85	°C
	焊接溫度 Soldering Temperature	T _{sol}	Reflow Soldering : 260 °C for 5 sec	

◆ 光電特性(Ta=25°C)

Electro-Optical Characteristics (Ta=25°C)

參數名稱 Parameter		符號 Symbol	最小 Min.	規格 Typ.	最大 Max.	單位 Unit	測試 條件 Condition
Input	Forward Voltage	V_F	-	1.2	1.5	V	$I_F=20mA$
	Reverse Current	I_R	-	-	10	μA	$V_R=5V$
	Peak Wavelength	λ_P	-	940	-	nm	$I_F=20mA$
Output	Dark Current	I_{CEO}	-	-	100	nA	$V_{CE}=20V$ $E_e=0mW/cm^2$
	C-E Saturation voltage	$V_{CE(sat)}$	-	-	0.4	V	$I_C=2mA$ $E_e=1mW/cm^2$
Transfer Characteristics	Collect Current	$I_{C(ON)}$	0.5	-	10	μA	$V_{CE}=5V,$ $I_F=20mA$
	Rise Time	T_r	-	15	-	μs	$V_{CE}=5V$ $I_C=1mA$
	Fall Time	T_f	-	15	-	μs	$R_L=1000\Omega$

● 典型特性曲線

Typical Electrical/Optical/Characteristics Curves for IR

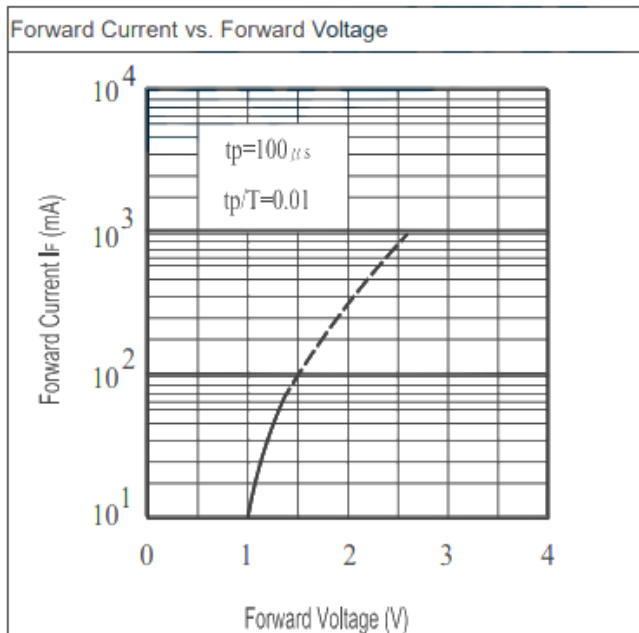
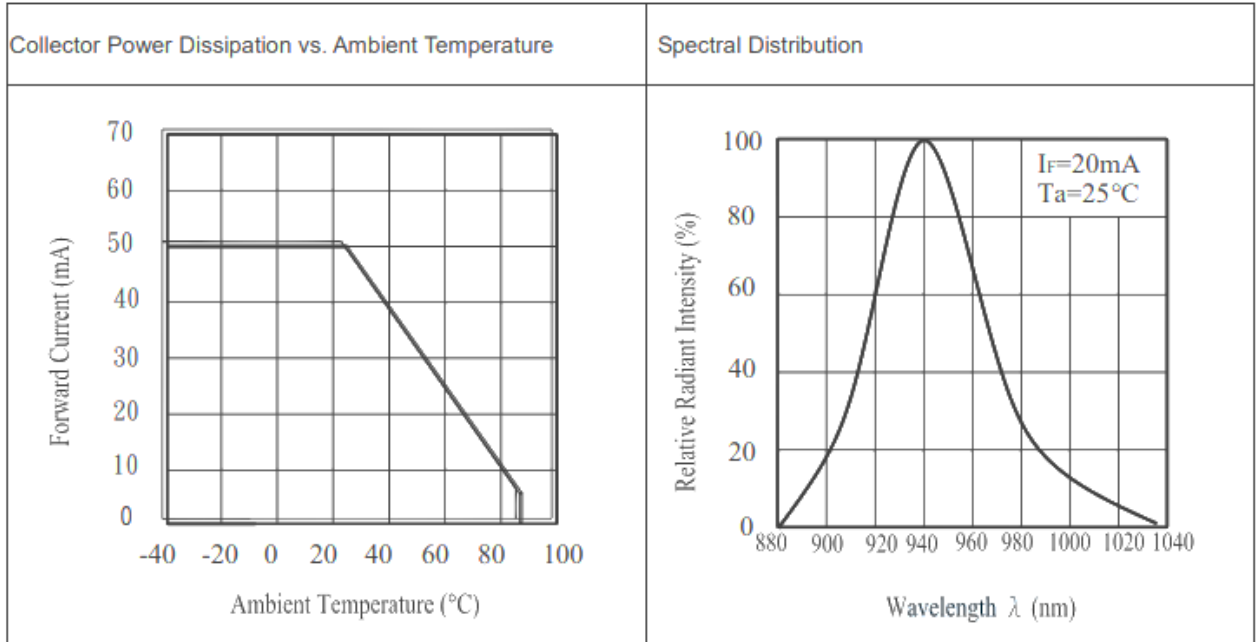

Typical Electrical/Optical/Characteristics Curves for PT

Spectral Sensitivity

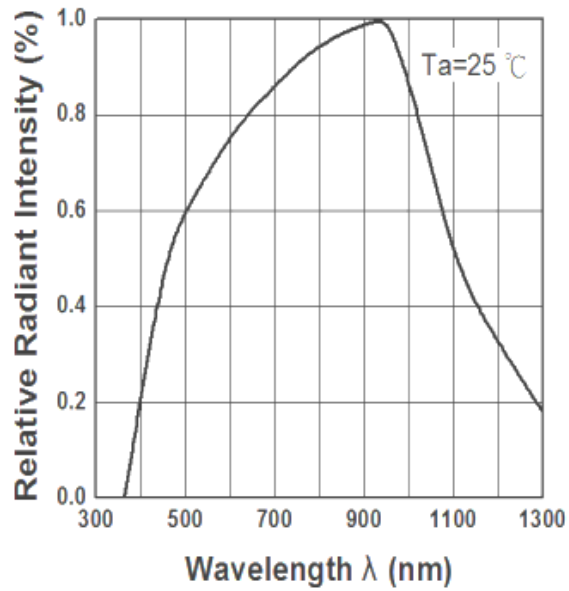

◆ 包裝規格說明 Packing Specification

靜電包裝袋 Anti-electrostatic bag

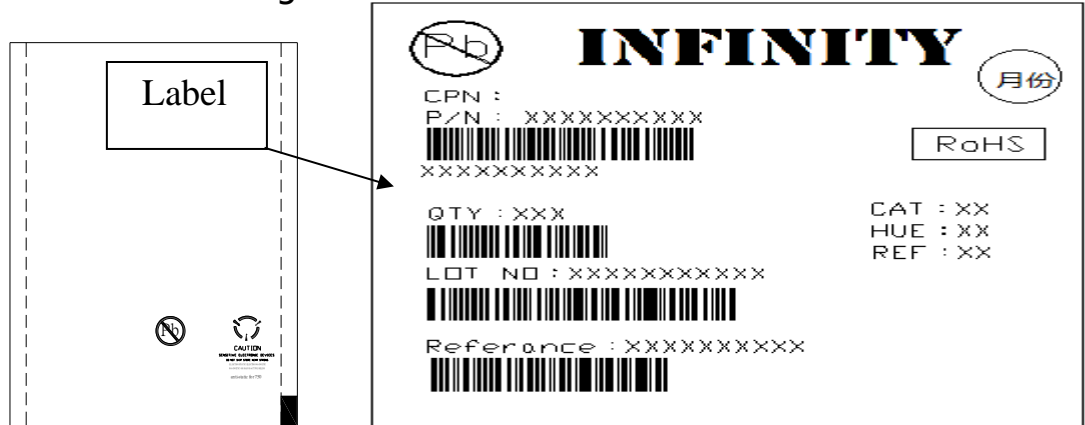

包裝試樣說明 (Label Form Specification)

- CPN: 客戶物料編號 Customer' s Production Number
- P/N: 物料代碼 Production Number
- QTY: 包裝數量 Packing Quantity
- CAT: 光強等級範圍 Ranks of Luminous Intensity and Forward Voltage
- HUE: 波長等級範圍 Rank of Dominant Wavelength
- REF: 追蹤代碼 Reference
- LOT No: 批次號 Lot Number

注意事項 Notes

(1) 使用烙铁人手焊接 The use of iron hand soldering

- 低密度产品焊接时推荐使用功率低于25W的烙铁或热风枪，焊接时烙铁的温度必须保持在260°C以下，且每个电极只能进行一次焊接，每次焊接的持续时间不得超过3秒。当第一次没有焊接好时，必须停10s后才可以焊接，第二次焊接还是没有焊接好时，必须更换新SMD灯。

A soldering iron or heat Gun of less than 25W is recommended to be used in hand soldering of low density products. Please Keep the temperature under 260°C while soldering . Each terminal of the LED is to go for less 3 second and for one time only. If it failed first time, 10secs cooling is necessary and then continue soldering, failed second time, must replace a new SMD LED.

- 焊接时烙铁头不要触到SMD LED胶体部份。

Do not contact the resin of SMD LED with the tip of soldering iron.

- 焊接时不要有任何机械压力施加在产品胶体顶部。

No mechanical stress should be exerted on the resin of SMD LED during soldering.

- 焊接完产品后，只有当产品温度降到40°C以下时才可以进行后续的处理，这是为了防止产品由于后续工作的机械的热压力而失效。

Post work after soldering should be done when the package has been cooled down to be low 40°C or less. This is to prevent the SMD LED failures due to thermal-mechanical stress during holding.

- 人手焊接过程中的不慎操作易引起LED产品的损坏，应当小心谨慎。

Be careful because the damage of the product is often started at the time of the hand soldering.

(2) 回流焊温度/时间 The Temperature Profile for SMD LED is shown below

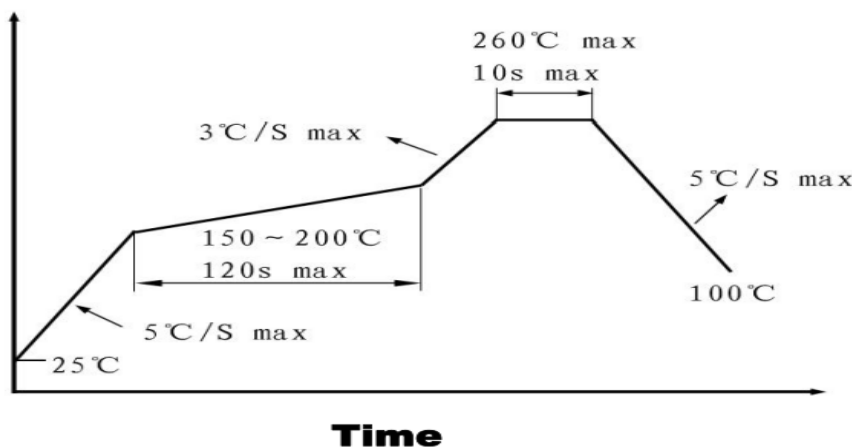

* 注 1：当焊接完成后，修焊接是不被推荐的。如实在不能避免，则修焊必须事先被验收合格以免由于修焊而被破坏 SMD LED 灯体；维修焊接时，请注意必须控制时间（参照使用烙铁人手焊接项）。

Modification isn't recommended on SMD LED after soldering. If can't be avoided, it must be pre-qualified to avoid damaging SMD LED; Please control the soldering time (refer to Manual soldering by soldering iron).

注 2：回流焊接最多只能进行一次；使用无铅回流焊时实际温度最大 260°C。

Reflow soldering should not be done more than one time. When using lead-free reflow soldering temperature to 260 °C.

注 3：在回流焊接近升温过程中，请不要对 LED 施加任何压力。

Don't put any physical stress while heating.

注 4：在焊接完成后，待产品温度下降到室温之后，再进行其它处理。

Don't do anything before the product cooling down to ambient temperature.

(3) 清洗 Cleaning

在焊接后推荐使用异丙醇来清洗，在温度不高于 30°C 的条件下持续 3 分钟，不高于 50°C 的条件下持续 30 秒。

使用其他类似溶剂清洗前，请先确认使用的溶剂不会对 LED 的封装和环氧树脂部分造成损伤。

基本上不建议使用超声波来进行清洗。若必须使用时，超音波的输出率以及电路板放置的位置也会对 LED 造成不同的影响，请在使用前确认没有异常。

It is recommended that alcohol be used as a solvent for cleaning after soldering. Cleaning is to go under 30°C for 3 minutes or 50°C for 30 seconds. When using other solvents, it should be confirmed beforehand whether the solvents will dissolve the package and Epoxy resin or not.

Basically using ultrasonic cleaning is not recommended. If you must use the output rate of ultra-sound and the position of the circuit board placed also had different effects on the LED, please con-firm no exception before use.

* 注：此一般指导原则并不适用于所有 PCB 设计和焊接设备的配置。具体工艺受到诸多因素的影响，请根据特定的 PCB 设计和焊接设备来确定焊接方案。

This general guideline may not apply to all PCB designs and configurations of all soldering equipment. The technique in practice is influenced by many factors, it should be specialized base on the PCB designs and configurations of the soldering equipment.

使用注意事项 Using Considerations

(1) LED 贮存 Storage

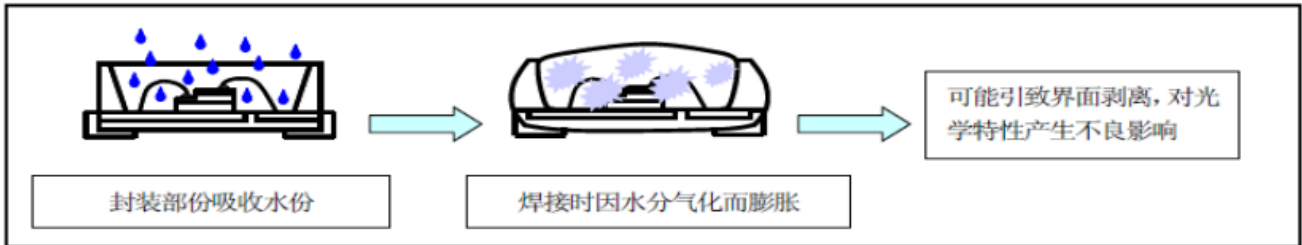

1. 本产品使用密封防潮防静电袋包装，并附有干燥剂，未开封的产品有 2 个月的保存时间；当存储时间超过规定的 2 个月时需重新烘烤。

This product use sealed moisture-proof anti-static bags and with desiccant. The max storage period before opening the package is 2 month. When the storage time has reached 2 month, baking treatment should be performed.

2. 开封前，产品须存放在温度不高于 30℃，湿度不高于 60%RH 的环境中。

Before opening the package, the product must be stored at temperature less than 30 °C and humidity less than 60%.

3. 开封后，产品应放入烤箱保存 65℃±5℃，产品应在 12 小时内用完。否则，应该以原包装的样式保存在防潮柜中。

After opening, store in the oven at 65℃±5℃ and use up within 12 hours. Otherwise, it should be kept in the original packaging in a moisture-proof cabinet

4. 我们建议打开包装超过 12 小时的在使用前应先烘烤，烘烤条件：65℃±5℃，48 小时；如打开包装超过 24 小时以上，请加长烘烤时间；如打开包装超过 48 小时以上，请勿使用，返回我司处理。

If the LEDs be kept over 12 hours, baking is required before mounting. Baking condition as below: 65℃±5℃ for 48 hours. Open the package than 24 hours please extend baking time ; Open the package than 48 hours please do not use and return to our company.

5. 使用前，请确认包装是否有破袋，若有破袋，请勿使用，返回我司处理。

Before use, please make sure that if the packing broken , if you have torn bags, please do not use and return to our company.

6. 使用前，请确认元件是否在储存时间内，若在 2 个月到 3 个月以内，使用前请先除湿，烘烤条件：65℃±5℃，48 小时；小批量试用 OK 无异常后，再批量使用，超过（包括）3 个月的元件请勿使用，返回我司处理。

Before use, please confirm whether the element in the storage time, if between two months and three months , please dehumidification firstly before use, Baking condition as below: 65℃±5℃ for 48 hours. small batch trial OK without exception, batch use again, do not use the element more than three months and return to our company.

(2) ESD (静电的防范) ESD(Electrostatic Discharge)

1. 静电和电涌会导致产品特性发生改变，例如正向电压降低等，如果情况严重甚至会损毁产品。所以在使用时必须采取有效的防静电措施。

Excessive ESD and surge voltage could change the property of LEDs. The LEDs will show some unusual characteristics such as lower forward voltage. And sometimes the LEDs will be damaged. So we must take some effective measures to prevent electrostatic.

2. 所有相关的设备和机器都应该正确接地，同时必须采取其它防止静电和电涌的措施。

All related equipment and machines should be properly grounded, at the same time must take other measures to prevent static and transient.

3. 使用防静电手环、防静电垫子、防静电工作服、工作鞋、手套、防静电容器，都是有效的防止静电和电涌的措施。

Use anti-static bracelet, anti-static MATS, anti-static overalls, work shoes, gloves, anti-static container, are effective measures to prevent static and transient.

(3) 设计建议 Design suggestions

1. 设计电路时，通过 LED 的电流不能超过规定的最大值，同时，还需使用保护电阻，否则，微小的电压变化将会引起较大的电流变化，可能导致产品损毁。

In designing a circuit, the current through each LED must not exceed the absolute maximum rating specified for each LED. In the meanwhile, resistors for protection should be applied, otherwise slight voltage shift will cause big current change, burn out may happen.

2. 建议使用以下(A)电路，该电路能够很好的调节通过每个 LED 的电流；不推荐使用(B)电路，该电路在持续的电压驱动下，LED 的正向电压 (VF) 发生变化，电流会随之而发生变化，可能使某些 LED 承受高于规定的电流值。

It is recommended to use the following (A) circuit. The circuit can very good adjust current through each LED; Not recommended (B) circuit, the circuit is under constant voltage driver, LED the forward voltage (VF) change, the current will subsequently and change, may make some LED to withstand higher than stipulated by the current value.

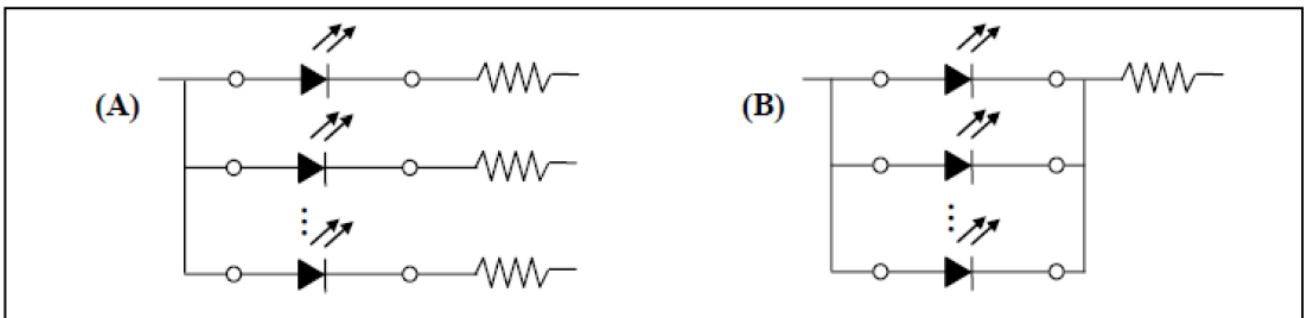

3. LED 的特性容易因为自身的发热和环境的温度的改变而发生改变。温度的升高会降低 LED 的发光效率、影响发光颜色等，所以在设计时应充分考虑散热的问题。

The characteristics of LEDs easily because of their heat and environmental temperature change and change, A rise in temperature will reduce the LED luminous efficiency and affect the emitting light colors, so should be given due consideration in the design of the cooling problem.

Others

- 以上規格如有變更，恕不另行通知，英利將保留對上述規格的材料變更權限。

Above specification may be changed without notice. Infinity will reserve authority on material change for above specification.

- 請嚴格遵守產品使用說明中概述的使用規範，如果不按規範使用本產品造成不良或損失者，英利將不承擔任何責任。

When using this product, please observe the absolute maximum ratings and the instructions for using outlined in these specification sheets. Infinity assumes no responsibility for any damage resulting from use of the product which does not comply with the absolute maximum ratings and the instructions included in these specification sheets.

- 該規格書包含英利公司版權保護資料，任何人在未得到英利公司授權允許的情況下，不得複製。

These specification sheets include materials protected under copyright of infinity's corporation. Please don't reproduce or cause anyone to reproduce them without Infinity's consent.